

- E** Instrucciones de montaje Kit de fijación
- C** Instruccions de muntatge Kit de fixació
- GB** Assembly instructions Fixation Kit
- F** Instruction de montage Kit fixation
- D** Montageanleitung Stützfuß-Kit
- PT** Instruções de montagem Kit fixação
- I** Istruzioni di montaggio Kit di fissaggio
- PL** Instrukcja montażu Element mocujący
- CZ** Montážní návod Fixační kit
- HU** Szerelési Utasítás Rögzítő készlet
- RO** Instrucțiuni de montaj Kit de fixare
- HR** Detaljne upute Kit za montažu
- TU** Öncelikle montaj Montaj kiti

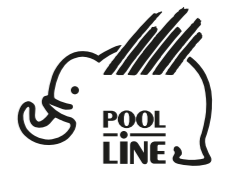

POOL-LINE ACCESORIOS, S.L.  
C. Esqueis, 19. P. I. Can Barri  
08415- Bigues i Riells. Barcelona (España)  
www.pool-line.net

Nº HOMOLOGACIÓN: **E9** 26R-03.1085

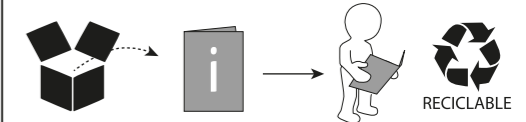

**110032**

Review 5/2019



Limpeza pre-instalación  
Pre-installation cleaning

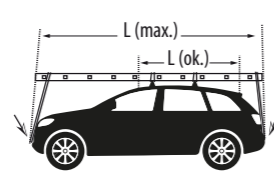

Revisar par de apriete  
Check torque

				P1	P2	P3	P4
<b>DACIA</b>							
LOGAN	05-12	4	B00015 + B00032	16	16	16	16
LOGAN	12-	4	B00032 + B00042	16	16	16	16
SANDERO	08-12	5	B00015 + B00032	16	16	16	16
SANDERO	12-	5	B00032 + B00042	16	16	16	16

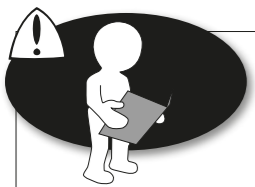

• SÓLO UTILIZAMOS UN TORNILLO  
• USE ONLY A SCREW

1

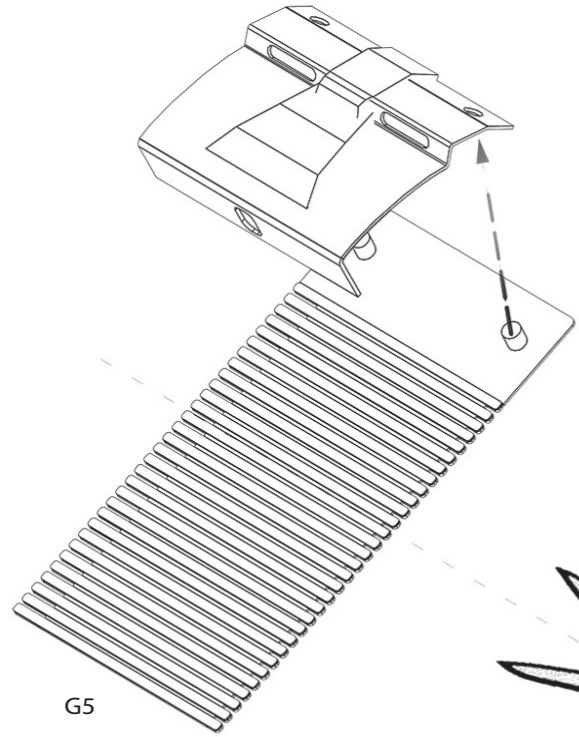

2

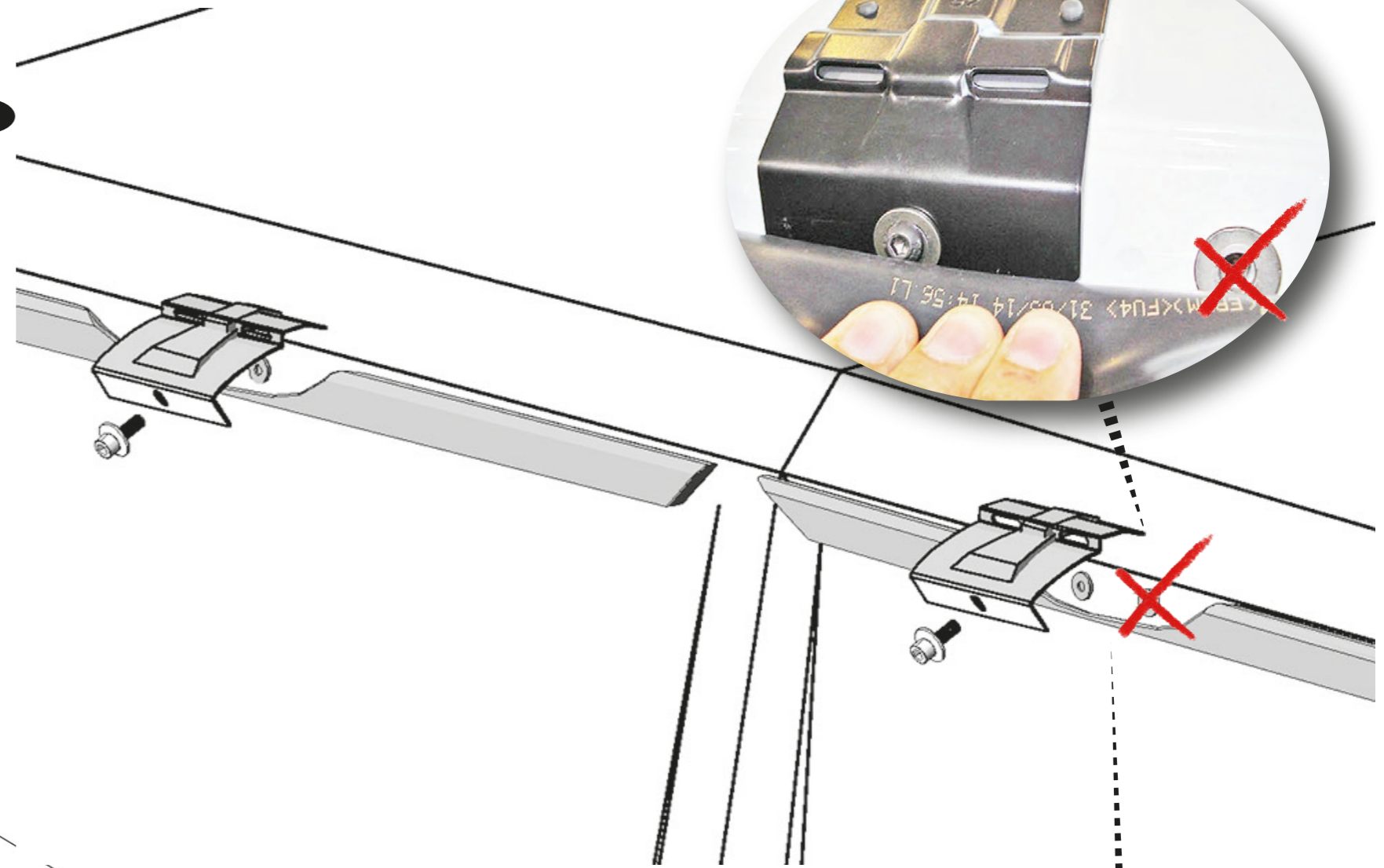

3

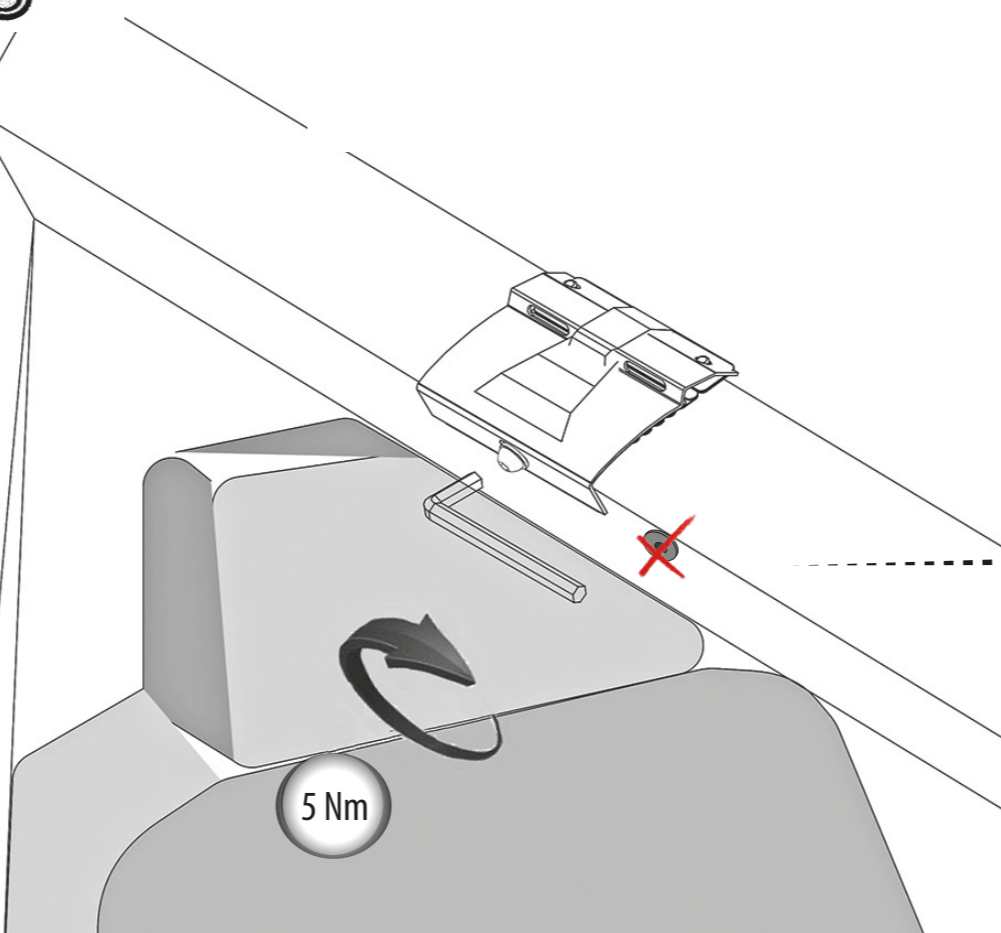
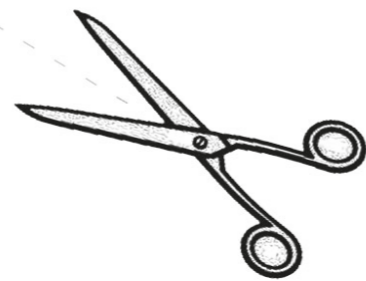

• SEPARAR/EXTRAER GOMA VEHÍCULO  
• SEPARATE / REMOVE RUBBER VEHICLE