

EVO

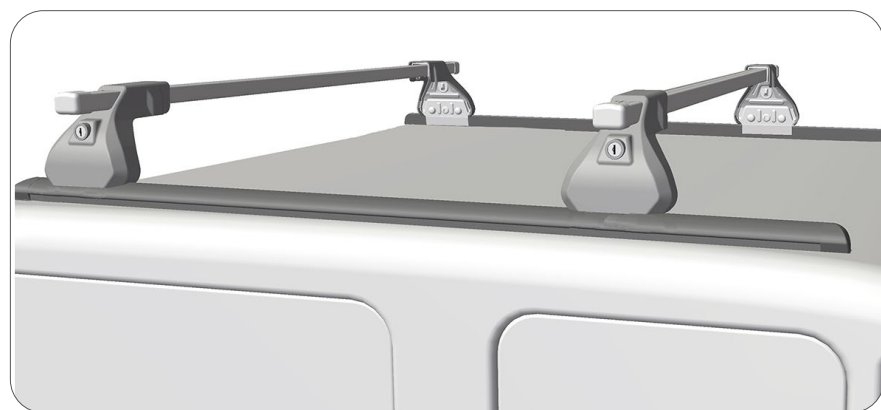

NEO

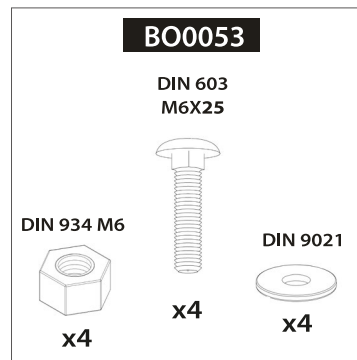
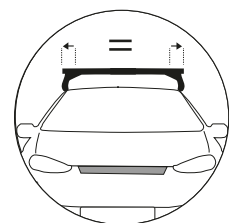
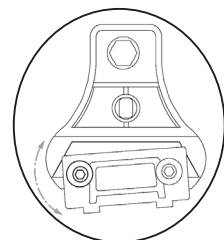
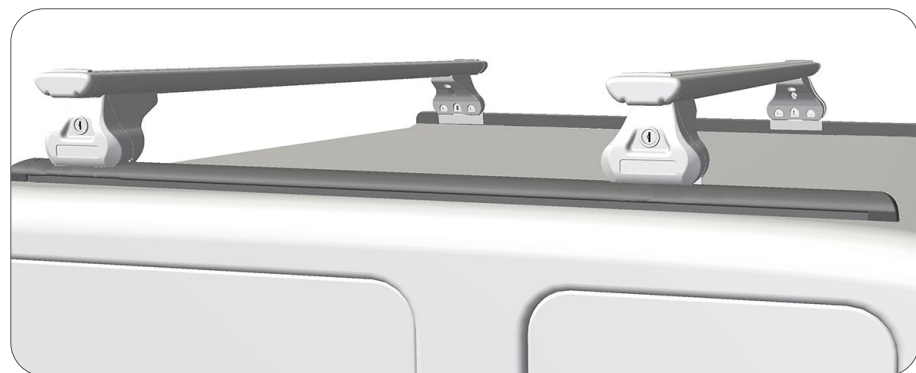
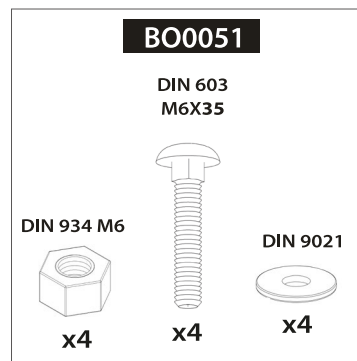

1 year Warranty

- E** Instrucciones de montaje Kit de fijación
- C** Instruccions de muntatge Kit de fixació
- GB** Assembly instructions Fixation Kit
- F** Instruction de montage Kit fixation
- D** Montageanleitung Stützfuß-Kit
- PT** Instruções de montagem Kit fixação
- I** Istruzioni di montaggio Kit di fissaggio
- PL** Instrukcja montażu Element mocujący
- CZ** Montážní návod Fixační kit
- HU** Szerelési Utasítás Rögzítő készlet
- RO** Instrucțiuni de montaj Kit de fixare
- HR** Detaljne upute Kit za montažu
- TU** Öncelikle montaj Montaj kiti

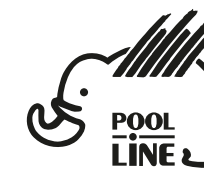

POOL-LINE ACCESORIOS, S.L.
C. Esqueis, 19. P. I. Can Barri
08415- Bigues i Riells. Barcelona (España)
www.pool-line.net

Nº HOMOLOGACIÓN: **E9** 26R-03.1085

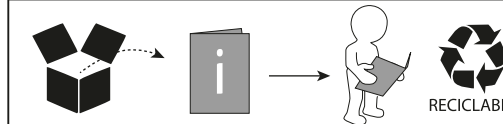

110423

Review 4/2015

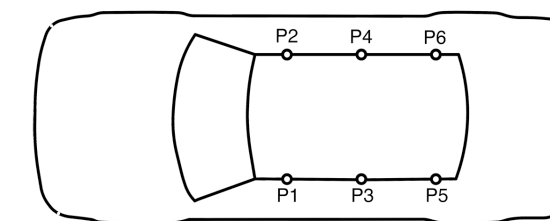
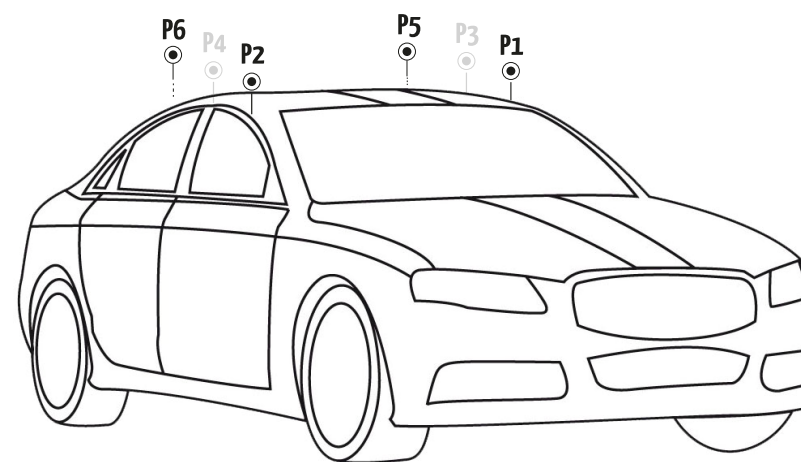

			EVO	NEO	P1	P2	P5	P6
SSANGYOUNG								
MUSSO	93 - 05	5	B00048 + B00053	B00048 + B00051	S20 + M	S20 + M	S20 + M	S20 + M

