

EVO

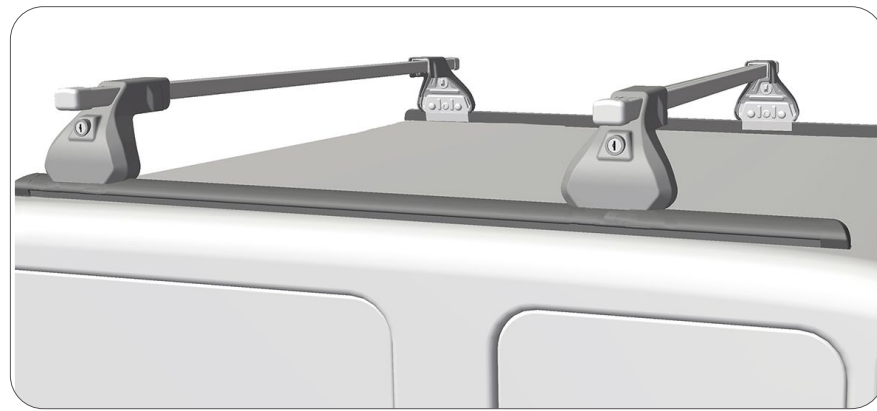

NEO

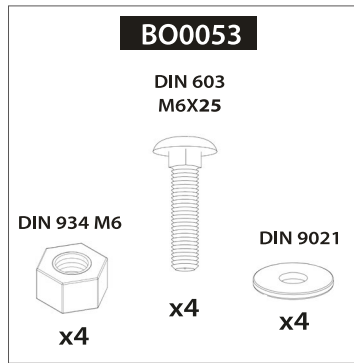
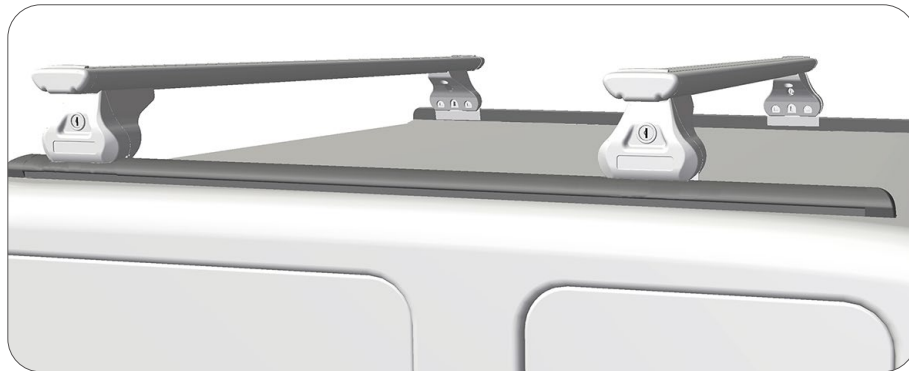
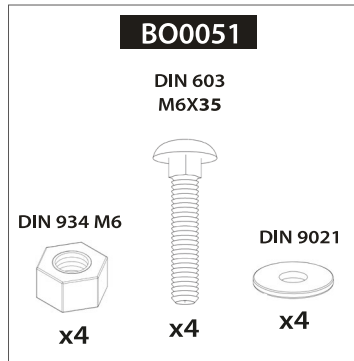

Rules Respect Traffic

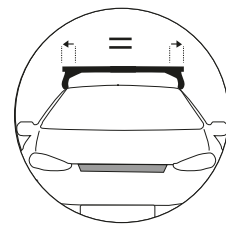
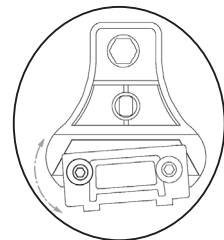

1 Year Warranty

- E** Instrucciones de montaje Kit de fijación
- C** Instruccions de muntatge Kit de fixació
- GB** Assembly instructions Fixation Kit
- F** Instruction de montage Kit fixation
- D** Montageanleitung Stützfuß-Kit
- PT** Instruções de montagem Kit fixação
- I** Istruzioni di montaggio Kit di fissaggio
- PL** Instrukcja montażu Element mocujący
- CZ** Montážní návod Fixační kit
- HU** Szerelési Utasítás Rögzítő készlet
- RO** Instrucțiuni de montaj Kit de fixare
- HR** Detaljne upute Kit za montažu
- TU** Öncelikli montaj Montaj kiti

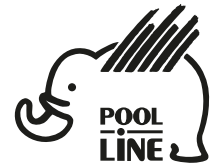

POOL-LINE ACCESORIOS, S.L.
C. Esqueis, 19. P. I. Can Barri
08415- Bigues i Riells. Barcelona (España)
www.pool-line.net

Nº HOMOLOGACIÓN: **E9** 26R-03.1085

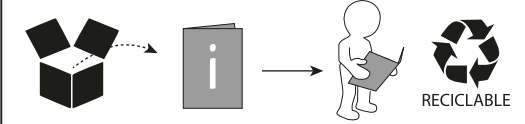

110429

Review 12/2015

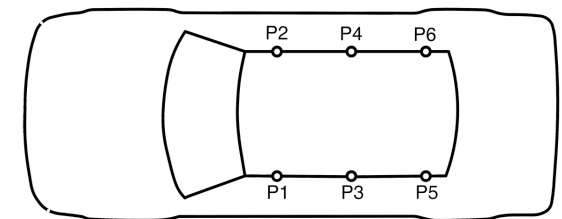
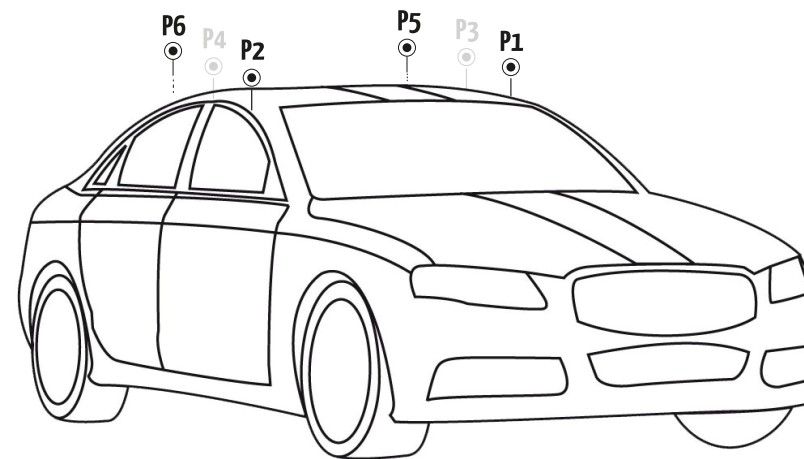

			EVO	NEO	P1	P2	P5	P6
TOYOTA								
COROLLA (E110)	97 - 01	5	B00048 + B00053	B00048 + B00053	S23 + C	S23 + C	S23 + C	S23 + C
COROLLA (E110) SEDAN	97 - 01	4	B00048 + B00053	B00048 + B00053	S23 + C	S23 + C	S23 + C	S23 + C

