

- E** Instrucciones de montaje
- C** Instruccions de muntatge
- GB** Assembly instructions
- F** Instruction de montage
- D** Montageanleitung
- PT** Instruções de montagem
- I** Istruzioni di montaggio
- PL** Instrukcja montażu
- CZ** Montážní návod
- HU** Szerelési Utasítás
- RO** Instrucțiuni de montaj
- HR** Detaljne upute
- TU** Öncelikle montaj

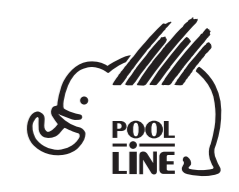

POOL-LINE ACCESORIOS, S.L.
 C. Esqueis, 19. P. I. Can Barri
 08415- Bigues i Riells. Barcelona (España)
 www.pool-line.net

50 **KG. MAX.**

Nº HOMOLOGACIÓN: **E9** 26R04/00*1085*01

RECICLABLE

ECO-FIX
111001

Review 12/2022

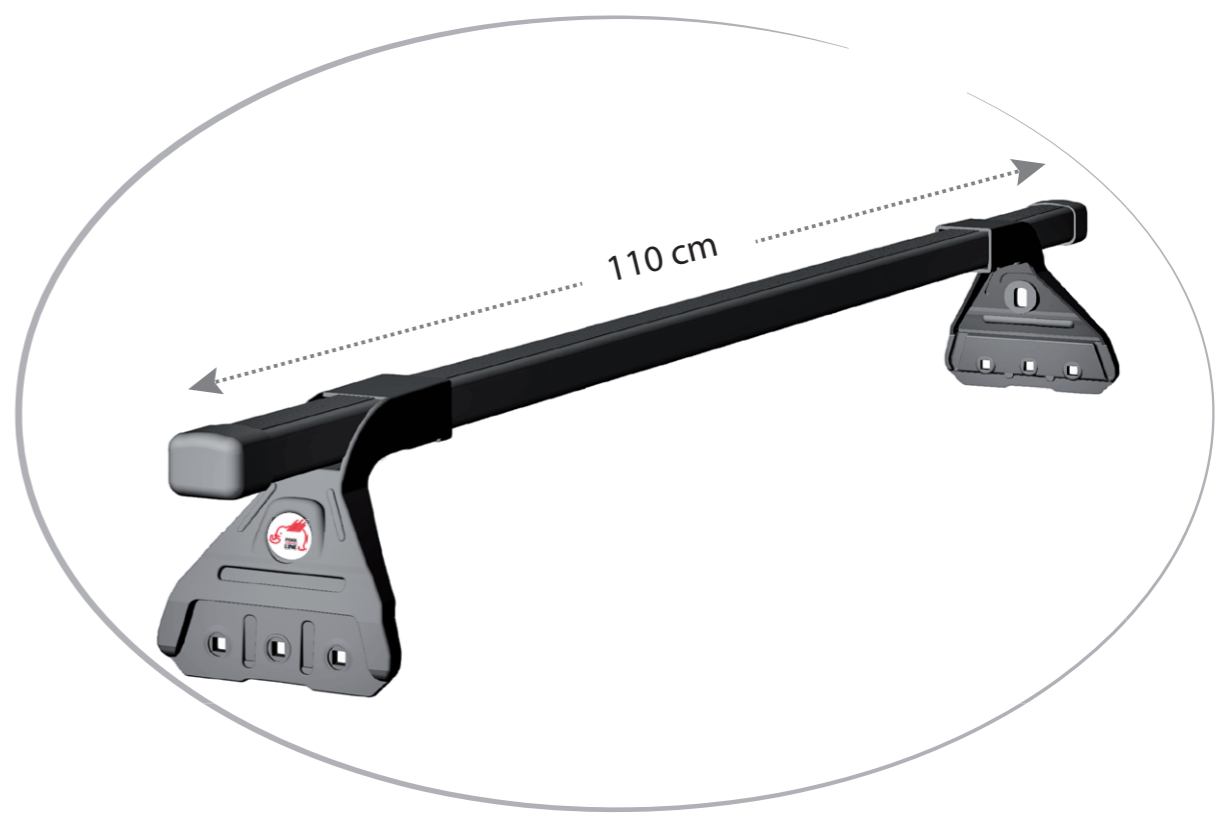

Nota: Guardar instrucciones para posibles montajes y desmontajes.

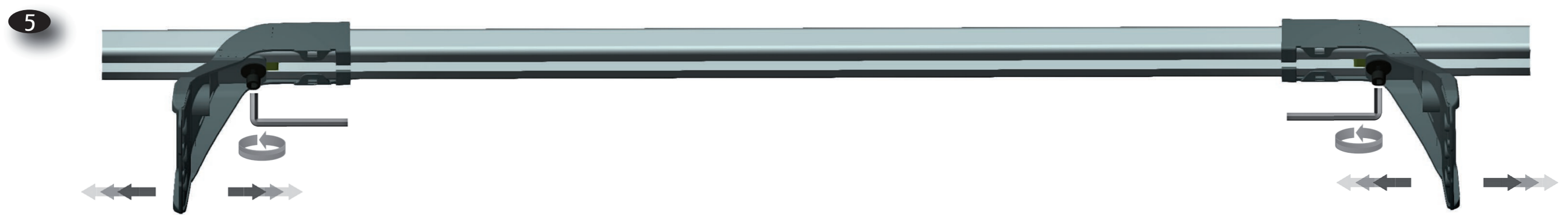
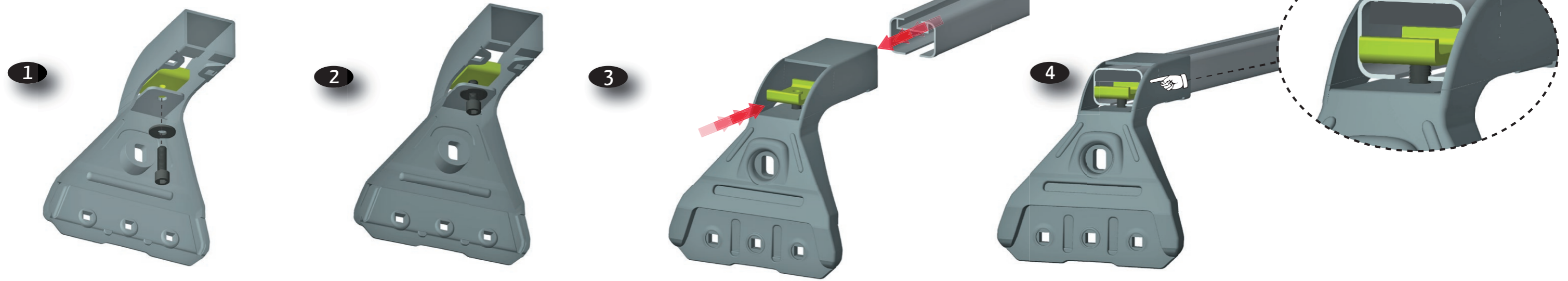



TECK-FIX

A

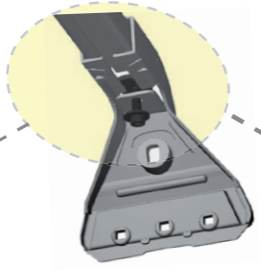

B

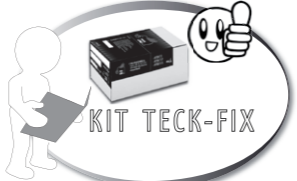
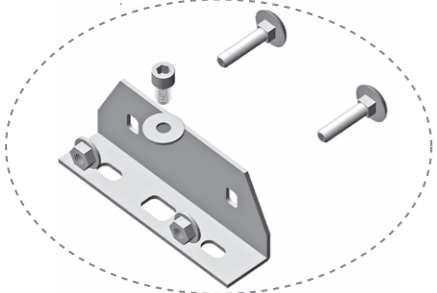
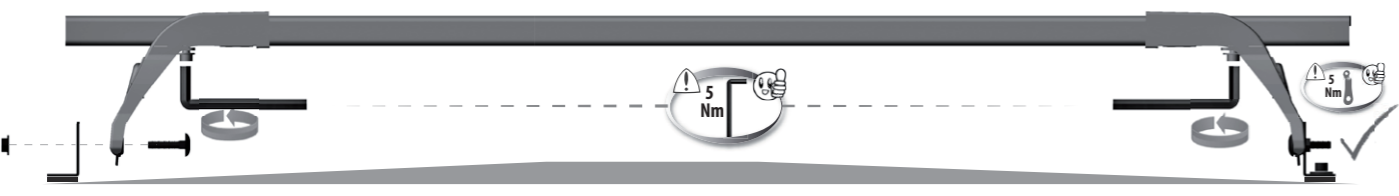

TECK-RAIL

A

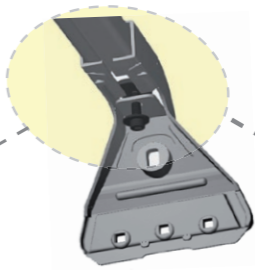

B

