

- E Instrucciones de montaje
- C Instruccions de muntatge
- GB Assembly instructions
- F Instruction de montage
- D Montageanleitung
- PT Instruções de montagem
- I Istruzioni di montaggio
- PL Instrukcja montażu
- CZ Montážní návod
- HU Szerelési Utasítás
- RO Instrucțiuni de montaj
- HR Detaljne upute
- TU Öncelikle montaj

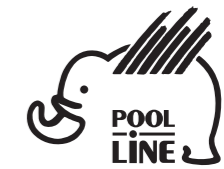

POOL-LINE ACCESORIOS, S.L.  
 C. Esqueis, 19. P. I. Can Barri  
 08415- Bigues i Riells. Barcelona (España)  
 www.pool-line.net

! 50 KG. MAX.

Nº HOMOLOGACIÓN: E9 26R04/00\*1085\*01

! i → ! RECYCLABLE

**EVO-FIX II**  
**111014**

Review 12/2022

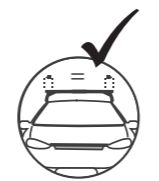
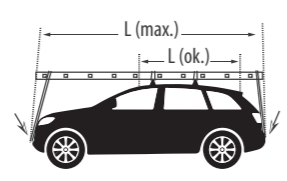
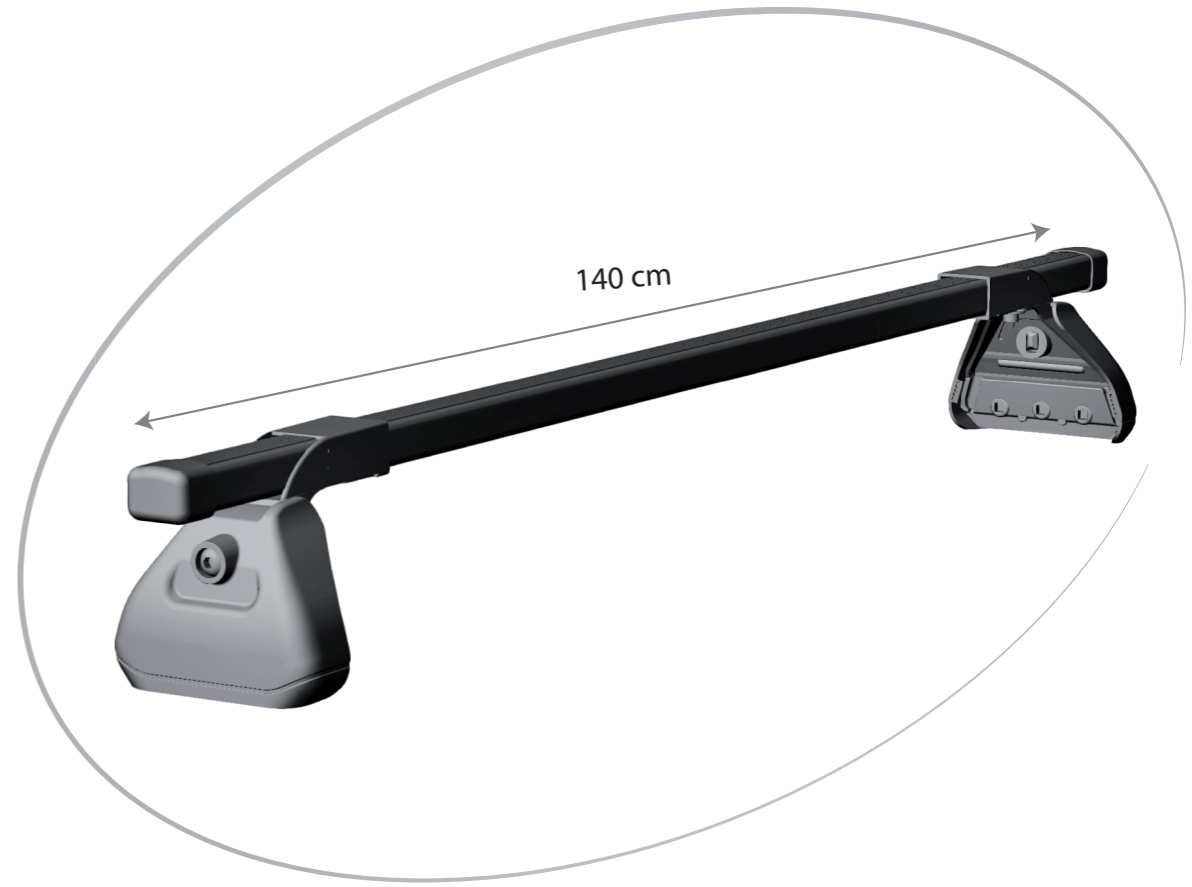

Nota: Guardar instrucciones para posibles montajes y desmontajes.



1

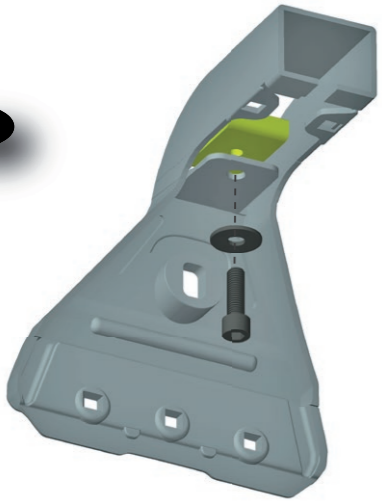

2



3

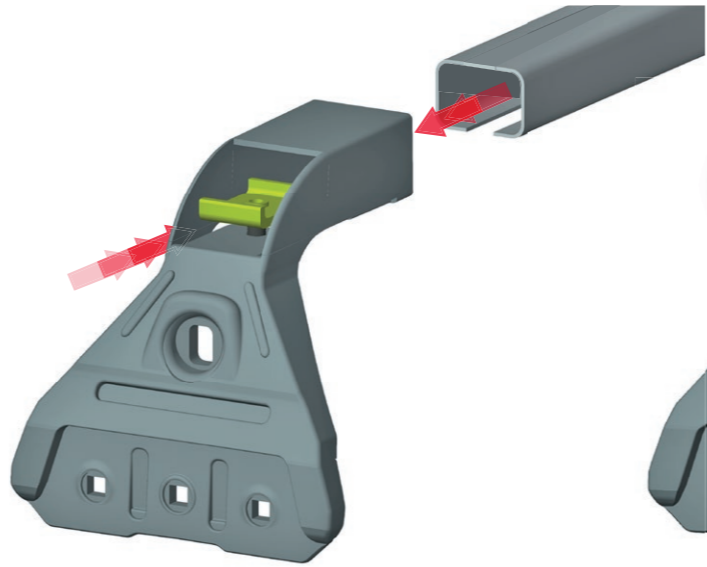

4

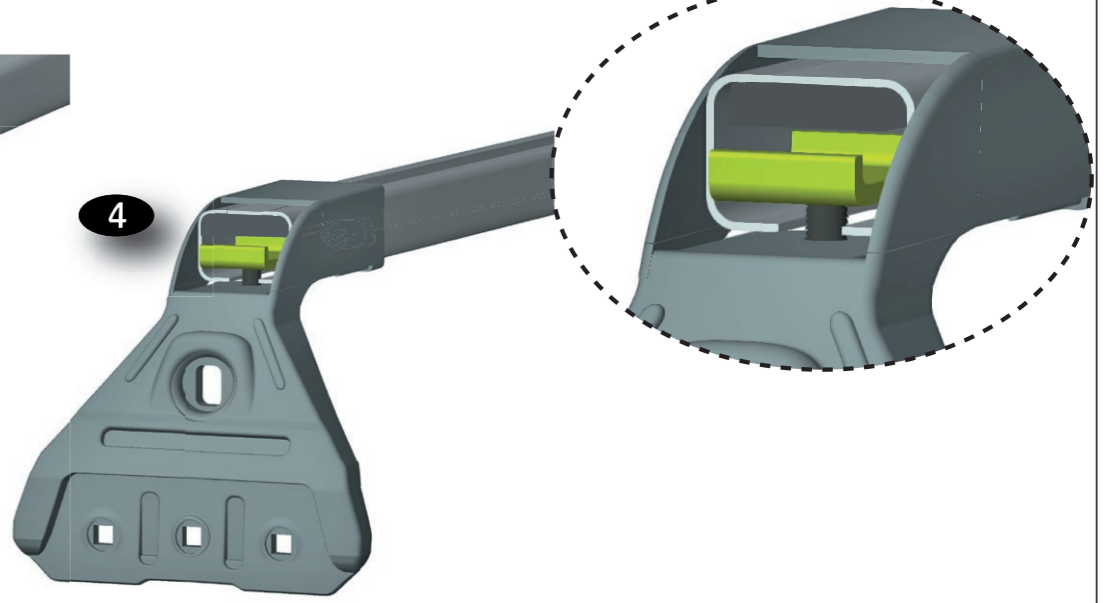

5

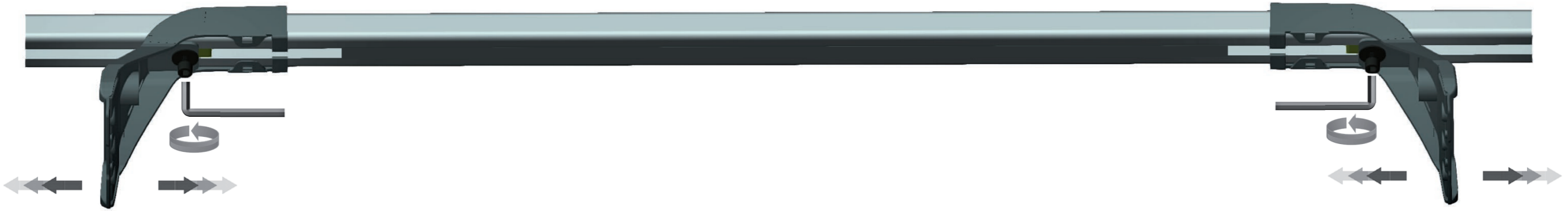

6

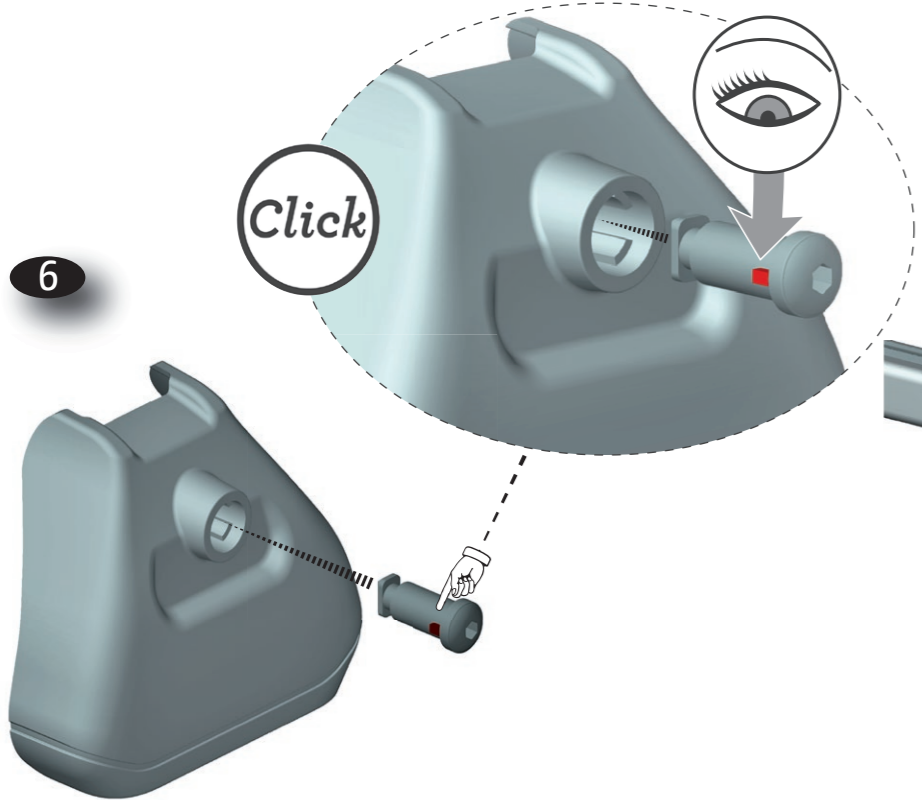

7

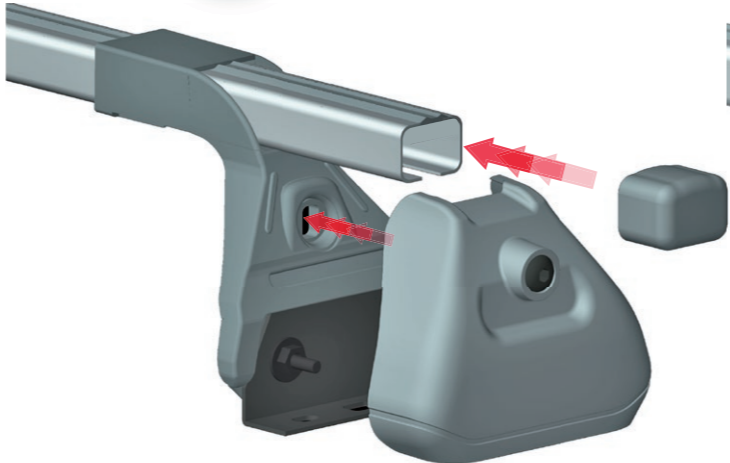

8



9



