

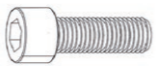

N	Q
1	4
2	2+2
3	4
4	2
5	1
6	1

N	BO0060	Q
8	 DIN912 M6x20	16
9	 DIN125	16

N	BO0035	Q
10	 ISO 7380 M8x20	4

N	BO0032	Q
11	 DIN 125 Ø8	4

- E** Instrucciones de montaje Kit de fijación
- C** Instruccions de muntatge Kit de fixació
- GB** Assembly instructions Fixation Kit
- F** Instruction de montage Kit fixation
- D** Montageanleitung Stützfuß-Kit
- PT** Instruções de montagem Kit fixação
- I** Istruzioni di montaggio Kit di fissaggio
- PL** Instrukcja montażu Element mocujący
- CZ** Montážní návod Fixační kit
- HU** Szerelési Utasítás Rögzítő készlet
- RO** Instrucțiuni de montaj Kit de fixare
- HR** Detaljne upute Kit za montažu
- TU** Öncelikle montaj Montaj kiti

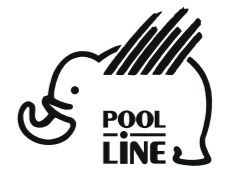

POOL-LINE ACCESORIOS, S.L.
C. Esqueis, 19. P. I. Can Barri
08415- Bigues i Riells. Barcelona (España)
www.pool-line.net

Nº HOMOLOGACIÓN: **E9** 26R-03.1042

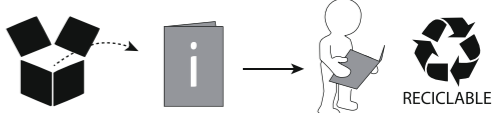



RECYCLABLE

121161

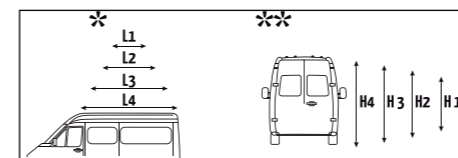
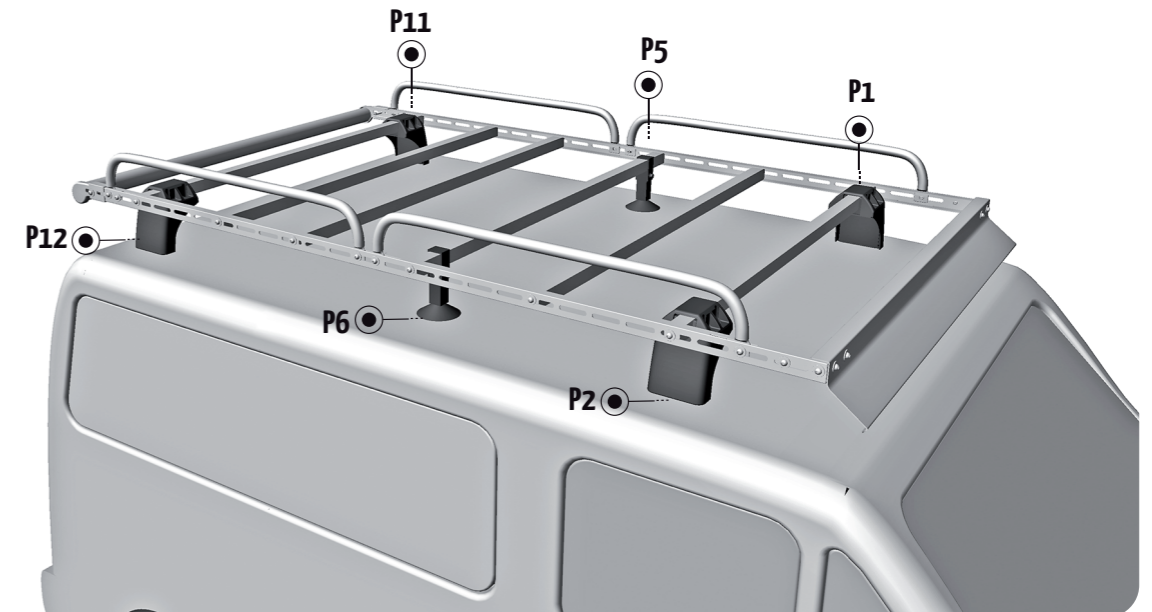
Rv: 01/2021



	L*	H**			P1	P2	P3	P4	P5	P6	P7	P8	P9	P10	P11	P12
Mercedes																
Citan W415	L2	H1	12 - 21	B00032+B00035	225	226			VENT6.5	VENT6.5					226	225
Nissan																
NV250	L2	H1	19 - 21	B00032+B00035	225	226			VENT6.5	VENT6.5					226	225
Renault																
Kangoo II	L2	H1	08 - 21	B00032+B00035	225	226			VENT6.5	VENT6.5					226	225



Limpeza pre-instalación
Pre-installation cleaning

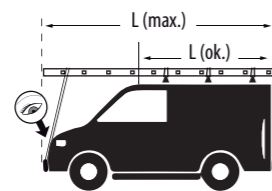

Revisar par de apriete
Check torque

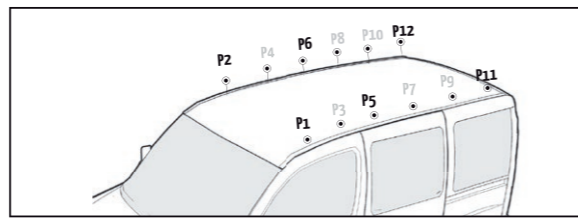

P1	P2	P3	P4	P5	P6	P7	P8	P9	P10	P11	P12
XXX	XXX			XXX	XXX					XXX	XXX
XXX	XXX			XXX	XXX					XXX	XXX
XXX	XXX			XXX	XXX					XXX	XXX
XXX	XXX			XXX	XXX					XXX	XXX
XXX	XXX			XXX	XXX					XXX	XXX
XXX	XXX			XXX	XXX					XXX	XXX
XXX	XXX			XXX	XXX					XXX	XXX
XXX	XXX			XXX	XXX					XXX	XXX
XXX	XXX			XXX	XXX					XXX	XXX
XXX	XXX			XXX	XXX					XXX	XXX
XXX	XXX			XXX	XXX					XXX	XXX

Pag. 1

⌚	10	P1	P1
0X	B0000XX		
0X-	B0000XX		
	B0000X		

Pag. 1

6 Nm

P1	P2	P3	P4	P5	P6	P7	P8	P9	P10	P11	P12
XXX	XXX			XXX	XXX					XXX	XXX
XXX	XXX			XXX	XXX					XXX	XXX
XXX	XXX			XXX	XXX					XXX	XXX
XXX	XXX			XXX	XXX					XXX	XXX
XXX	XXX			XXX	XXX					XXX	XXX
XXX	XXX			XXX	XXX					XXX	XXX
XXX	XXX			XXX	XXX					XXX	XXX
XXX	XXX			XXX	XXX					XXX	XXX
XXX	XXX			XXX	XXX					XXX	XXX
XXX	XXX			XXX	XXX					XXX	XXX
XXX	XXX			XXX	XXX					XXX	XXX

Pag. 1

5 Nm

5 Nm