

- E** Instrucciones de montaje
- C** Instruccions de muntatge
- GB** Assembly instructions
- F** Instruction de montage
- D** Montageanleitung
- PT** Instruções de montagem
- I** Istruzioni di montaggio
- PL** Instrukcja montażu
- CZ** Montážní návod
- HU** Szerelési Utasítás
- RO** Instrucțiuni de montaj
- HR** Detaljne upute
- TU** Öncelikle montaj

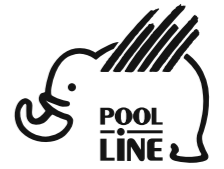

POOL-LINE ACCESORIOS, S.L.  
 C. Esqueis, 19. P. I. Can Barri  
 08415- Bigues i Riells. Barcelona (España)  
 www.pool-line.net





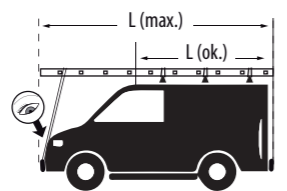











	<b>200</b> <b>KG.</b> MAX.
Nº HOMOLOGACIÓN: <b>E9</b> 26R-03.1042	
RECICLABLE	

**123113**  
 Rv: 01/2020



**CITROËN BERLINGO II / PEUGEOT PARTNER II ( 2008-> )**  
**(Versión con trampilla / Version with trap door)**



N		Q
1	 S-1350	1
2	 L-1540	2
3	 B-1262	2
4	 T-1335	5
5		2
6		10
7		2
8		4
9		1
10	 CHA-M8	6
12	 ISO 7380 M8x40	10
13	 ISO 7380 M8x16	14
14	 DIN 125 Ø 8	24
15		4
16	 DIN 603 M6x12	2
17	 DIN 6923 M6	2

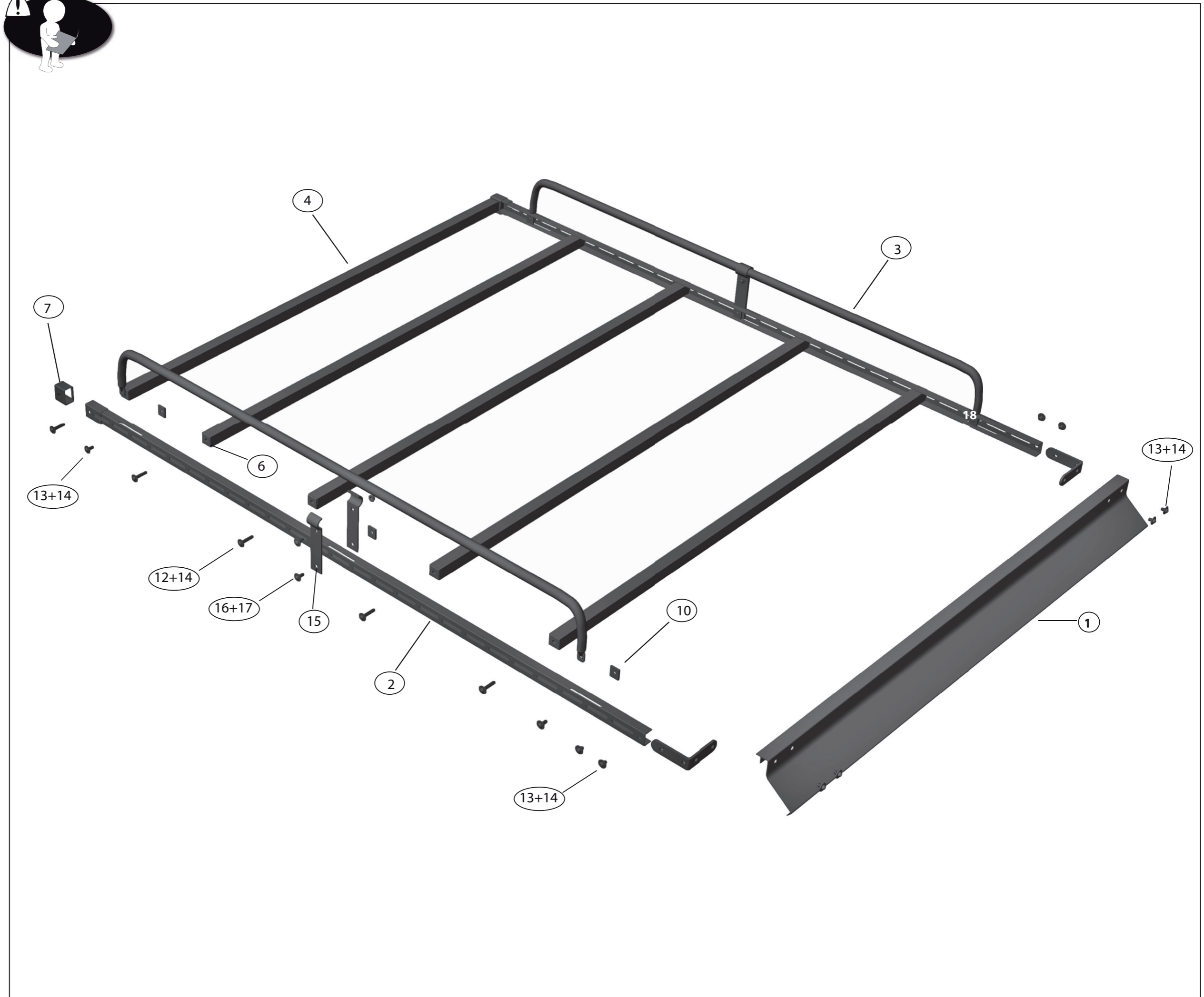

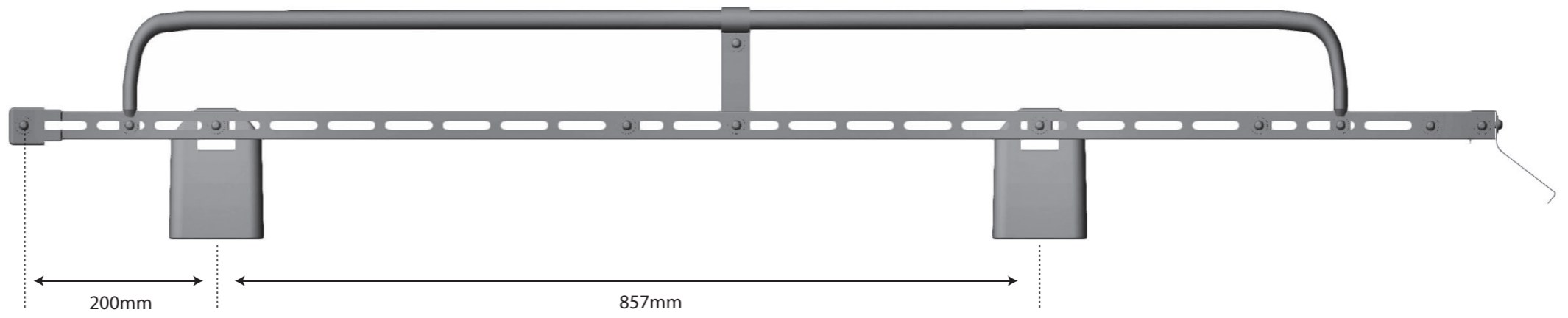
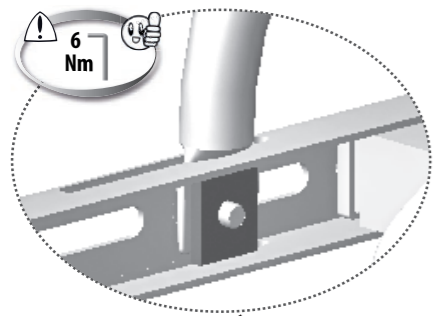

Zona delantera  
Zone avant  
Front zone  
Zone anteriore  
Vorderzone

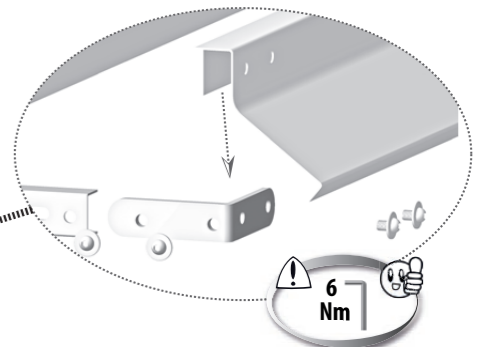
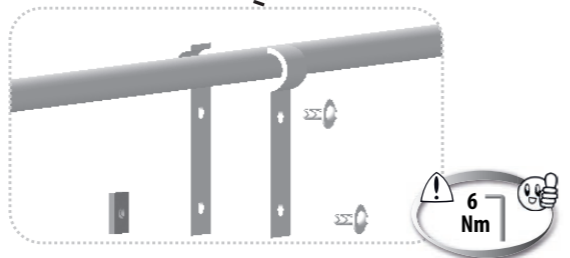
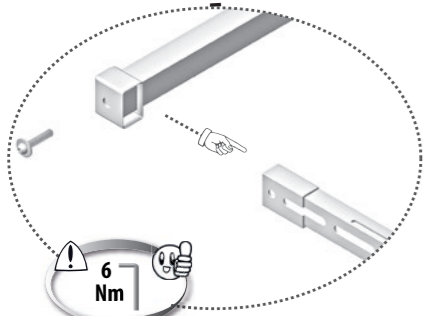

8

